



## ICE-60 60kW DC Fast Charger



### Description

The In-Charge Energy ICE-60 is an All-in-One DC Fast Charger, which supports both CCS and CHAdeMO standards with one or two connectors. This DC All-in-One is designed for easy installation and high reliability. This product is easy to operate with an intuitive touchscreen display that facilitates access control, charging status and help menus. The ICE-60 is ideal for auto dealers, fleet charging and a variety of parking applications where DC charging is needed in minimal space.

### Key Benefits and Features

- 150 to 1000Vdc output voltage range supports new high voltage DC charging voltages
- 60kW rated output power
- User friendly control interface allows for PIN or RFID accessibility
- Tempered glass touchscreen LCD display for added durability and daylight readability
- OCPP 1.6 standard supports integration into In-Control, In-Charge's EVSE management platform
- LTE Modem and LAN for connectivity to In-Control
- Compact design for space saving power-to-footprint ratio
- TUV certification to UL 2202 to ensure safety
- 480V 3-phase input for high efficiency conversion
- TUV Certified

### Specifications

- Available with single CCS, Dual CCS1 and CCS1 & CHAdeMO connectors
- DIN70212 and ISO15118-2 protocols supported
- Materials and Finish: Enclosure - Hot galvanized steel; Facade - Plastic; Screen - Tempered glass
- Dimensions (D x W x H): 29.5" x 27.5" x 68.9" / 750mm x 700mm x 1750mm
- Weight: 708lbs / 321kg



The ICE-60, 120 and 180 share the same housing

## Ordering Information

Configuration	SKU
ICE-60kW DC Fastcharger - Dual CCS1	ADC-60-480-C1C1-AC1R
ICE-60kW DC Fastcharger - CCS1& CHAdeMO	ADC-60-480-C1CH-AC1R
ICE-60-CC CCR	IDC-60-480-C1C1-AC1C
ICE-60-CC Cold Weather	IDC-60-480-C1C1-AC1R-CW
ICE-60-C1LC1L	IDC-60-480-C1LC1L-AC1R
ICE-60-CJ CCR	IDC-60-480-C1CH-AC1C

## Technical Specifications

Configuration	SKU
Voltage	480 Vac +/- 10 %, WYE
AC Input Power Connection	3-phase: L1, L2, L3, GND
Frequency	60 Hz
Recommended breaker	100A 3W+G circuit
SCCR	25 kAIC
Max Current Draw	86A
Power factor	>0.99
THD - Current	< 5%
Output Parameters	Value
Voltage	150 - 1000Vdc
Current - Max	200A@300V / 120A@500V / 60A@1000V
Power - Max	60kW
System Efficiency - Max	>95%
Controls and Interface	Value
Charging Connectors	CCS1, CHAdeMO
HMI	7" TFT LCD Display
Communication	OCPP 1.6J
Network Connection	4G/5G modem; LAN 10/100M
RFID	ISO14443 Type A & S50, S70 MIFARE
Language	English (others available on request)
Environment	Value
Temperature - Operating	-4°F to 113°F/ -20°C to +45°C * (Optional: -40°F / -40°C)
Temperature - Storage	-40°F to 158°F/-40°C to +75°C
Humidity	0 - 95
Altitude - Operating	6560ft (2000 m)
Protection - Intrusion	IP54, NEMA 3R; indoor and outdoor rated
General	Value
Cable Length	16.4 ft (25ft available upon request)
Safety and EMI	UL2202, CE, EN6100-6-3, EN61851-1/-23/-24

\* Derating characteristics apply at extreme temperatures



Name	SKU	Certified As	Certification Number
ICE-60-CC	IDC-180-480-C1C1-AC1R	Shenzhen Infypower Co., Ltd. EXP60K2-FD-UU2, EXP60K2-FS-U2	TUV: <a href="#">CU 72212743</a>





## ICE- 60/120/180 Series Fast DC Charger Installation and Operation Manual



Version: 2

Last Time Edited: 5/22/2023

In-Charge Energy Inc.

All rights reserved. This manual may be subject to change without notice.

<https://inchargeus.com/>

Service hotline: 818-697-GOEV

## IMPORTANT SAFETY INSTRUCTIONS

- Please read the operating instructions and notes carefully before starting operation in order to prevent accidents. The "Caution, Attention, Warning and Danger" statements in the products and product manual do not represent all safety matters to be observed and are intended to supplement various operational safety precautions.
- During the various operations of our products and equipment, it is necessary to comply with relevant National Safety Regulations and strictly observe the precautions and special safety instructions of the related equipment.

### Electrical Safety

#### High Voltage

 <b>Danger</b>	Since some parts of this power system are under high voltage during operation, direct or indirect contact can be fatal.
---	---

- It is necessary to comply with relevant National Safety Regulations during the installation of the Portable DC Charger. Personnel who install and maintain this equipment must be qualified to work with high DC voltage up to 1000Vdc and 3-phase AC voltage up to 500Vac.
- It is strictly forbidden to wear watches, bracelets, bangles, rings and other conductive objects on the wrist during installation and maintenance.
- If there is water inside the DC Charger enclosure, AC power and DC connector must be disconnected immediately. During operation in a humid environment, water should be strictly prevented from entering the equipment.
- During installation, it is strictly forbidden to operate the DC Charger and an "Operation prohibited" signboard must be used.

 <b>Danger</b>	Construction operation of high voltage lines may cause fire or electric shock. The wiring area and the area where the line passes through for AC cables must comply with national and local regulations and norms. As this device utilizes high voltages do not attempt to install this equipment if you are not a qualified electrician.
---	---

#### Tools

 <b>Warning</b>	Special tools must be used during various operations involving high DC and AC voltages.
--	---

## Thunderstorm

 <b>Danger</b>	It is strictly forbidden to carry out live installation and maintenance work during thunderstorms.
---	--

A strong electromagnetic field will be produced in the atmosphere during a thunderstorm. Therefore, the equipment should be well grounded to avoid damage to the equipment due to lightning strikes.

## Static Electricity

 <b>Caution</b>	Static electricity generated by the human body may damage electrostatic sensitive components on the circuit boards, such as the large-scale integrated circuit (IC), etc. Before handling any patch boards, circuit boards and IC chips, it is necessary to wear an anti-static wrist strap with the anti-static wrist strap wire connected to Ground to avoid damage to sensitive components due to static electricity.
--	--

## Short circuit

 <b>Danger</b>	During operation, it is strictly forbidden to short-circuit the positive and negative of the DC Charger DC distribution or short-circuit any DC distribution polarity to Ground. The DC Charger is a high voltage DC power supply, and short circuit may cause damage to the DC Charger and personal safety hazards.
---	--

- During work with High Voltage DC output, it is necessary to strictly check the polarity of cables and interface terminals.
- The space for DC power distribution work is compact and attention should be paid to planning cable routing etc. before starting any installation work.
- Insulated tools must be used.
- During live work, attention should be paid to keeping hands, arms tools etc. away from live high voltage parts to avoid accidents.

## Others

### Sharp Corners of Objects

 <b>Warning</b>	During the handling of equipment by hand, it is necessary to wear protective gloves to prevent injuries caused by sharp objects.
--	--

### Power Cable

 <b>Caution</b>	Make sure that the cable label is correct before the connection of cables.
--	--

### Signal Cables

 <b>Caution</b>	Signal cables should be kept away from power cables, with a minimum distance of 100mm.
--	--

## Table of Contents

1 General Product Description .....	5
2 General Characteristics .....	5
2.1 Technical Specification .....	5
2.3 Model description .....	7
2.4 Standards .....	7
3 Product Parts Presentation .....	8
4 Installation .....	9
4.1 Grounding instructions .....	9
4.2 Unpacking and visual inspection .....	9
4.3 Assembly/placing instructions .....	9
4.3.1 Preparation of concrete foundation .....	10
4.3.2 Cabinet Installation .....	11
4.3.3 Power cables connections .....	12
4.3.4 Riser Installation	
5 Start-Up .....	14
5.1 Verification and inspection .....	14
5.2 Switch on .....	14
6 User Manual .....	16
6.1 Output connector .....	16
6.1.1 CCS Connector .....	16
6.1.2 CHAdeMO Connector .....	17
6.2 Operation instructions .....	17
Appendix 1 Engineering and Technical Parameters .....	19
Appendix 2: Alarm information .....	21
Appendix 3: Error codes and possible solutions .....	22



## **1 General Product Description**

- The ICE- 60/120/180 is able to fast charge all electric vehicles compliant with Combined Charging System (CCS) and CHAdeMO charging system standards.
- IP55 for use in harsh environments
- This charger is rated to charge at full power at the following temperature range: -22°F~122°F (-30°C~50°C)
- LTE wireless modem support, RFID authorization and Mobile App payment support

## **2 General Characteristics**

### **2.1 Technical Specification**

The Technical Specifications of the ICE-60/120/180 are shown in Table 1.

This system is intended to have at least one DC output connection (CCS and/or CHAdeMO).

Technical Data		Description	Remarks
Nominal Input	Phases/Lines	3 phases + PE	
	Voltage	480Vac (+/-10%)	
	Frequency	45 – 60 Hz	
	Current	60:86A ;120:150A; 180: 222A	
	Power	60: 60kW ; 120: 120kW; 180: 180kW	
	Power factor	≥0.99	
	System Efficiency	≥ 94.5% (Full load)	
DC Output CCS1	Voltage	150~1000Vdc	
	Current	60: 60A @ 1000V; 120: 120A @ 1000V; 180: 180A @ 1000V	
	Nominal Power	180kW	
DC Output CHAdeMO	Voltage	200~500Vdc	
	Current	125A	
	Nominal Power	62.5kW	
Cabinet	Dimensions(W*D*H)	700*750*1750 (mm)	
	Weight	60: 708lbs / 321kg;120: 804lbs / 364kg; 180: 900lbs / 408kg	
	Protection Degree	IP55, IK10	
HMI and Command Unit	Local interface	TFT Color touch display 7"	
	Communication	Router 4G/5G (GSM or LTE)	
	Protocol	Ocpp1.6	
Environment conditions	Operating temperature <sup>1</sup>	-40°F ~ 167°F ( -40°C ~ +75°C), Derating After 131°F (55°C)	
	Transportation/ Storage temperature	-40°F ~ 167°F ( -40°C ~ +75°C)	
	Humidity	5%RH~95%RH	
	Place of installation	Indoor / Outdoor	
	Altitude	2000m (6561 ft)	
	Sound Noise	≤65dB (nominal input/output power, the environment temperature is 77°F (25°C).)	
	Atmospheric pressure	80KPa~110KPa	
	Overvoltage category	II	
	Protection class	Class I	
Note 1: -40°C~+75°C, derating from 55°C			

## 2.3 Model description

NRTL Model Number	Model	Configuration	Remarks
EXP-180K2-FDW-UU2	ICE-180-CC	CCS-1 + CCS-1	180kW
EXP-180K2-FDW-UC2	ICE-180-CJ	CCS-1 + CHAdeMO	180kW
EXP-120K2-FD-UU2	ICE-120-CC	CCS-1 + CCS-1	120kW
EXP-120K2-FD-UC2	ICE-120-CJ	CCS-1 + CHAdeMO	120kW
EXP-60K2-FD-UU2	ICE-60-CC	CCS-1 + CCS-1	60kW
EXP-60K2-FD-UC2	ICE-60-CJ	CCS-1 + CHAdeMO	60kW

## 2.4 Standards

The EVSE (Electric Vehicle Supply Equipment) complies with the following standards:

Table 2 Applicable Standards

Technical Data	Norm	Remarks
Applicable Standards	IEC 61851-1 <sup>1</sup> IEC 61851-23 <sup>2</sup> IEC 61851-24 <sup>3</sup>	

1 **IEC 61851-1 2017**: Electric vehicle conductive charging system. Part 1: General Requirements

2 **IEC 61851-23 2014**: Electric vehicle conductive charging system - Part 23: DC electric vehicle charging station

3 **IEC 61851-24 2014**: Electric vehicle conductive charging system - Part 24: Digital communication between a DC EV charging station and an electric vehicle for control of DC charging

### **3 Product Parts Presentation**

The charging system is composed of DC charging cabinet and DC charging connector. The System can be installed outdoors.

The ICE-60/120/180 series fast DC Charger has various possible output combinations as shown in section 2.3 Model description:



*Figure 1: External View of ICE-60/120/180*

## 4 Installation

### 4.1 Grounding instructions

An equipment grounding conductor or a grounded, metal, and permanent wiring system is required for the EVSE charger connection. This should be run with circuit conductors and connected to the equipment grounding bar or lead on the EVSE.

### 4.2 Unpacking and visual inspection

- Check that the exterior packaging has been damaged by mechanical impacts or any accidents during transportation
- If applicable, check that the exterior panels of the ICE Charger are in perfect condition
- Check that the interior of the Charging Station is clean
- Check that the door of the Charging Station is working properly
- Check for proper Charging Station protective ground connection point, which should be interconnected with the low voltage switchboard ground connection during the installation

### 4.3 Assembly/placing instructions

- As shown in the figure below, the concrete foundation should be made, and the height of the base should not be less than 8in (200 mm) above grade.
- It is recommended to reserve a  $\Phi 3.5$ in (90mm) plastic pipe at the cable entrance, and the height of the pipe extending out of the foundation horizontal plane shall not be more than 3.15in (80mm).
- As shown in the figure below, mark the installation holes of four M12 expansion bolts on the concrete foundation.
- Open 4 holes on the concrete foundation, select the percussion bit of  $\Phi 0.63$ in (16mm) type, and use the percussion drill to drill the holes perpendicular to the ground at the above marked hole position, with the drilling depth of 2.36in~3.15in (60mm ~ 80mm).
- Use four M12  $\times$  60 expansion bolts equipped with attached accessories, slightly tighten the bolts, vertically put them into the hole, and knock them with a rubber hammer until all the expansion pipes enter the installation hole.
- Screw off the bolt, spring pad and flat pad in turn counterclockwise.

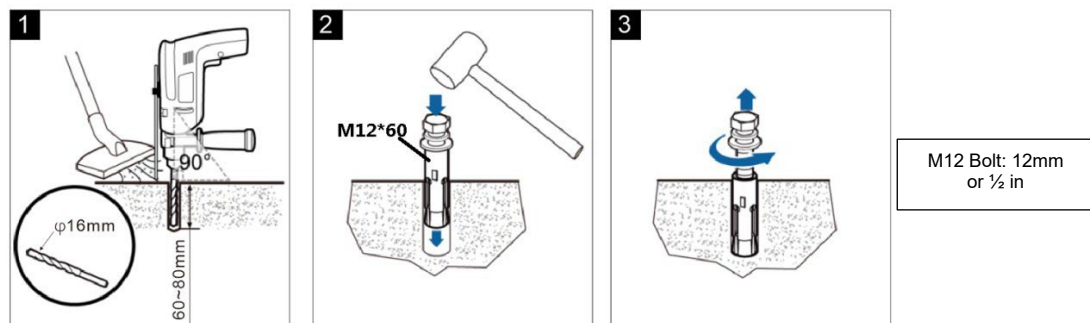

Figure 2: Anchor Installation

### 4.3.1 Preparation of concrete foundation

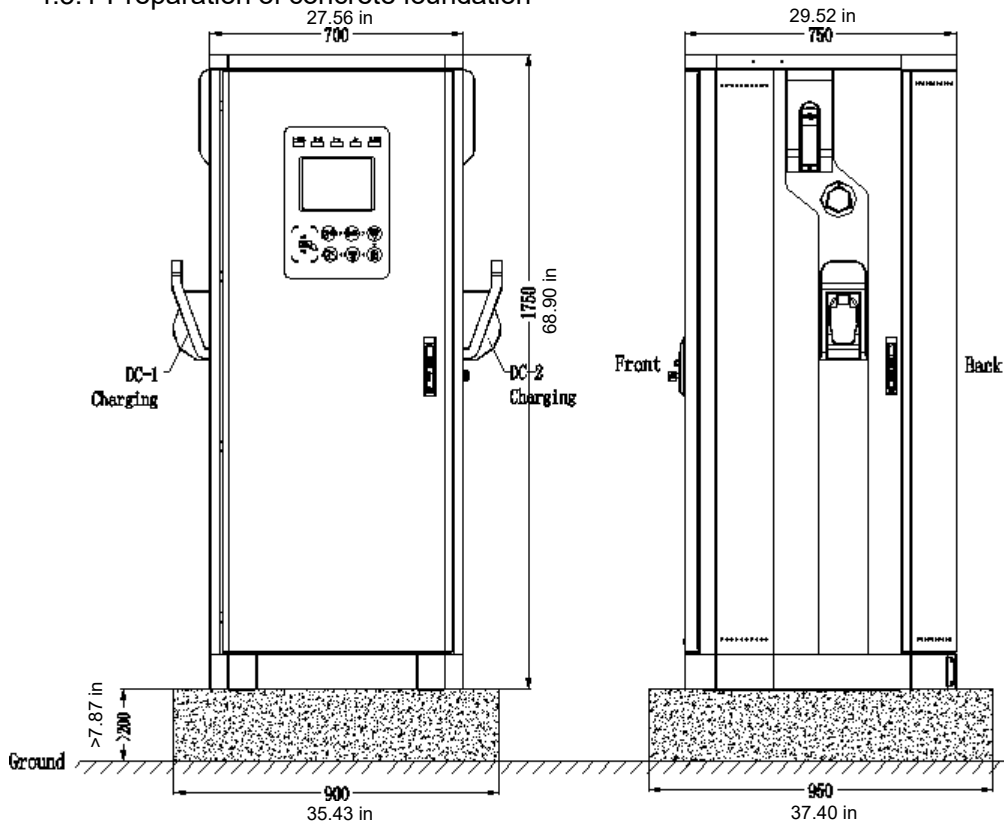

Figure 4: Concrete Pad

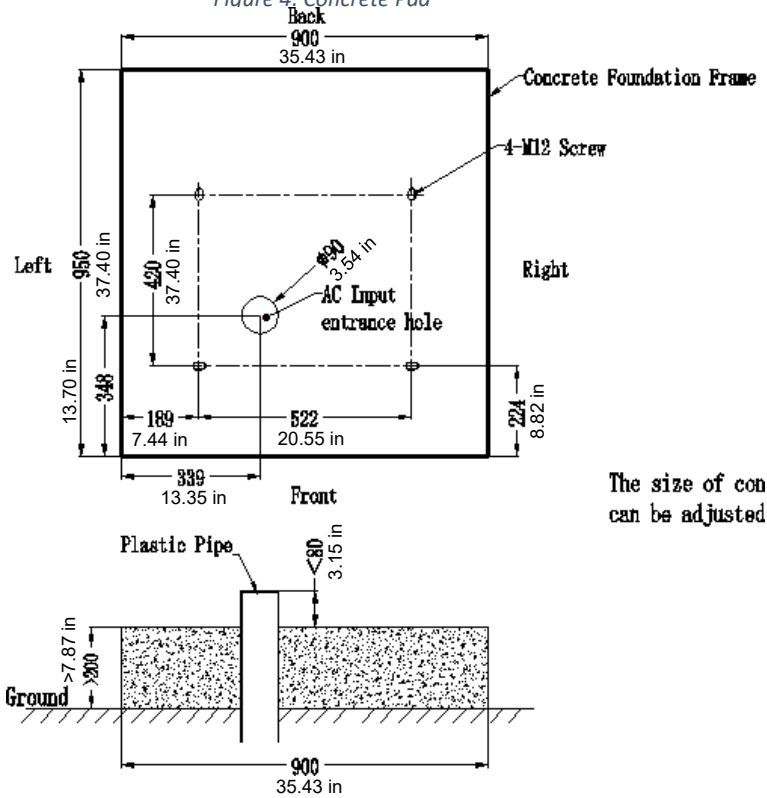

Figure 3: Concrete foundation top view

### 4.3.2 Cabinet Installation

- As shown in the figure below, the protective covers on both sides of the steel base of the cabinet can be removed, and the cabinet can be transported to the concrete foundation by forklift.
- Align the installation hole of the cabinet base and fix the cabinet to the concrete foundation with expansion bolts.

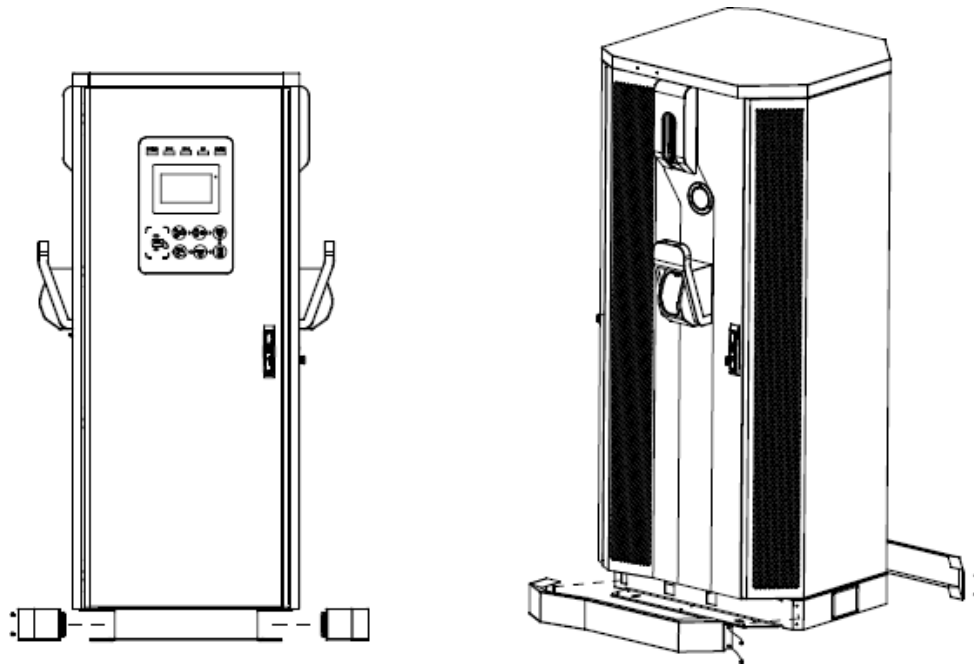
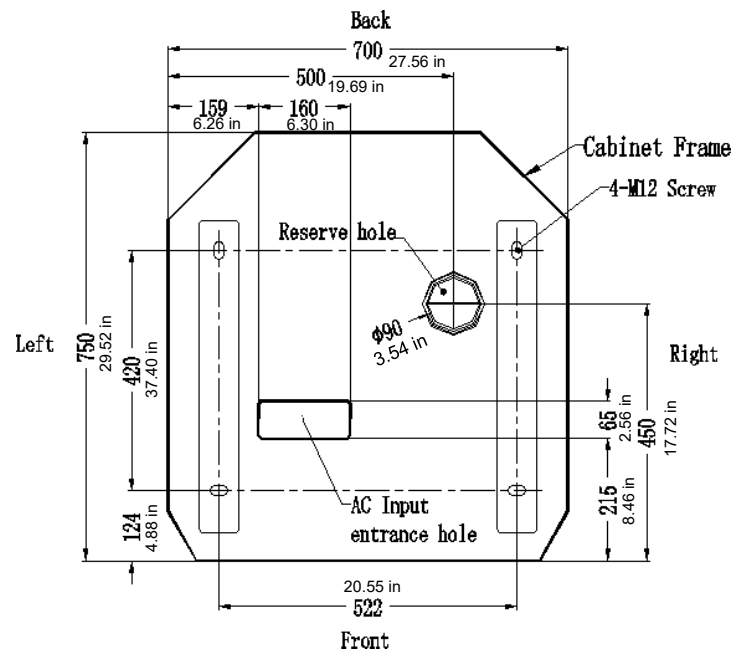

Figure 5:EVSE cabinet installation



## EVSE Top View

### 4.3.3 Power cables connections

End terminals for input wiring: 4 (four) end terminals for 3 phases + protective ground.

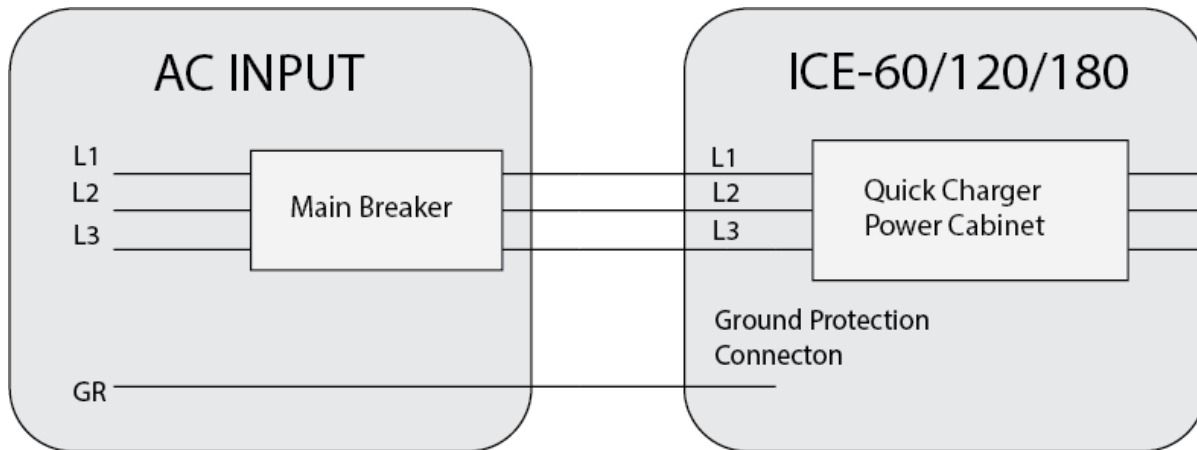

Figure 6: AC Input Wiring

Max. Power of charger	The section for AC feed cables	AWG	Amperage	Specification of terminal screw
180kW	3*185+2*95mm <sup>2</sup>	3/0	320A	L1/L2/L3 is M10 PE is M8
120kW	3*120+2*70mm <sup>2</sup>	2/0	224A	L1/L2/L3 is M10 PE is M8
60kW	3*95+2*50mm <sup>2</sup>	1	115A	L1/L2/L3 is M10 PE is M8

#### Notes:

- The AC feed power cables to the charger are not included.
- The AC feed power cables should be no less than 90°C temperature resistant grade.
- The protective MCCB must be installed on the customer's distribution cabinet, and the upper MCCB capacity shall not be less than 1.25 times of the input current.
- It is recommended that the upper MCCB should not be equipped with RCD function.
- This system is to be connected to a grounded, metal, permanent wiring system; or an equipment-grounding conductor is to be run with circuit conductors and connected to equipment-grounding terminal or lead on battery charger.



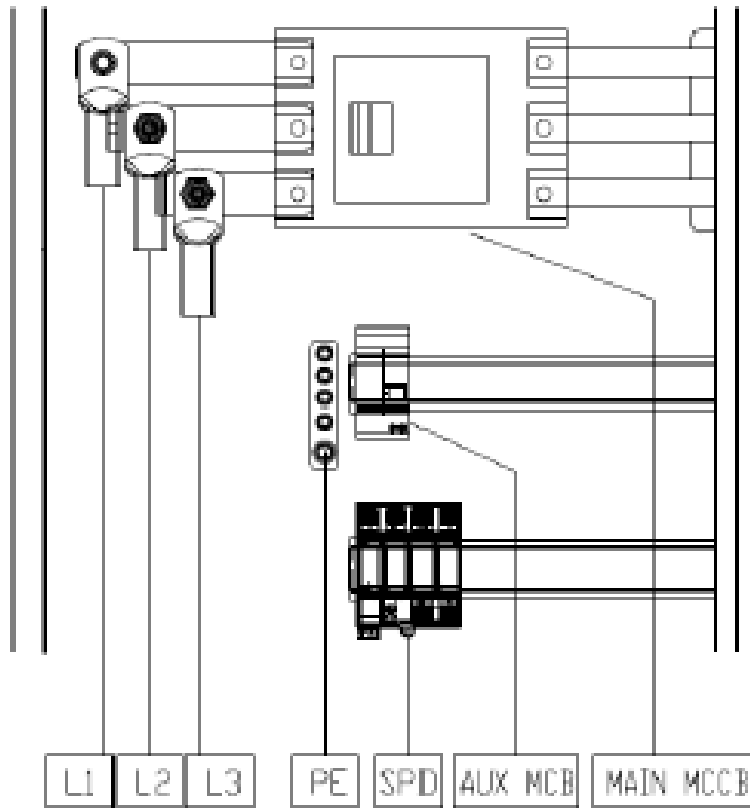
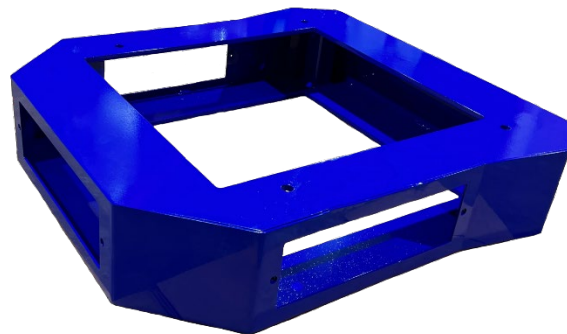

Figure 7: UL Wiring Diagram

#### 4.3.4 Riser Required Installation

- A riser is **required to be installed if the installation location has a preexisting concrete foundation.**
- A riser is **required to be used if the customer does not want to break ground to run the power wires.** Therefore, **any modifications to the chargers housing, such as cutting holes into the unit, will void all warranties.**
- The riser places the ICE-60, ICE-120, ICE-180 up six inches.
- Using a riser will still allow the charges HMI to still be ADA compliant.
- Comes with three plates to cover the side wall holes. All plates are the same, but holes can easily be punched out of the side wall cover for the power lines at the desired entry point.



Name	SKU
Rapid Base Platform	RMA-DP-FD

## 5 Start-Up

### 5.1 Verification and inspection

- Check if the bolts of the AC and protective ground cables of the EVSE are correctly tightened to the specified torque. The torque values are as follows:
  - M8: 20ft-lbs (15ft-lbs on M8 Ground screws)
  - M10: 40ft-lbs
- Check the resistance between the EVSE protective ground and the low voltage switchboard ground connection; the value must be according to local codes.
- Check the resistance on the Grid AC between phases and between phase and PE. Also check resistances between DC+/DC-/PE to ensure no dead shorts.
- Check that power modules panel address setting is correct.
- Before switching ON all the fuses and circuit breakers, check the supply voltage between lines: it must be 380Vac-520Vac. Also check between phases and phase to ground. Voltage should be 480V +/- 5% P to P and 277V +/- 5% P-PE for a 480V feed

### 5.2 Switch on

- Switch on the circuit breakers in the charging pile, Q1 and Q2 in turn.

*AC Input MCB For Rectifier Module (Q1)      AC Input RCD For Auxiliary Power(Q2)*

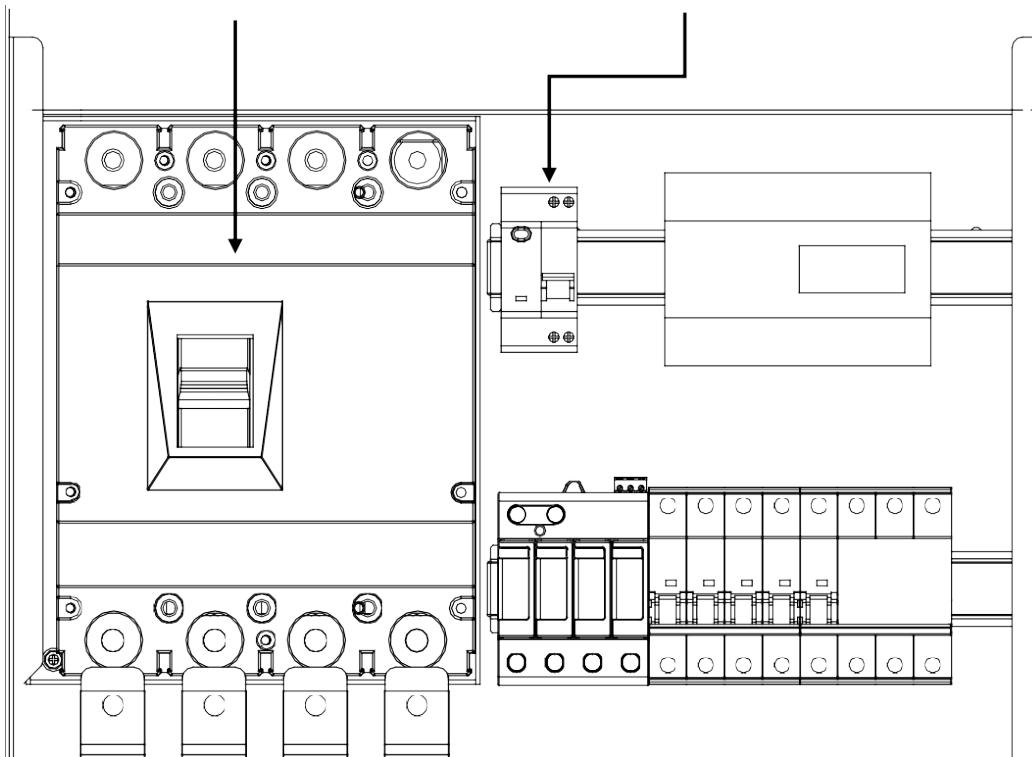

- Wait for a few seconds. The display will present a picture as below:



Figure 8: Loading Screen

- Finally, the display will present the following charging screen

**CCS1+CHAdeMO Units:**

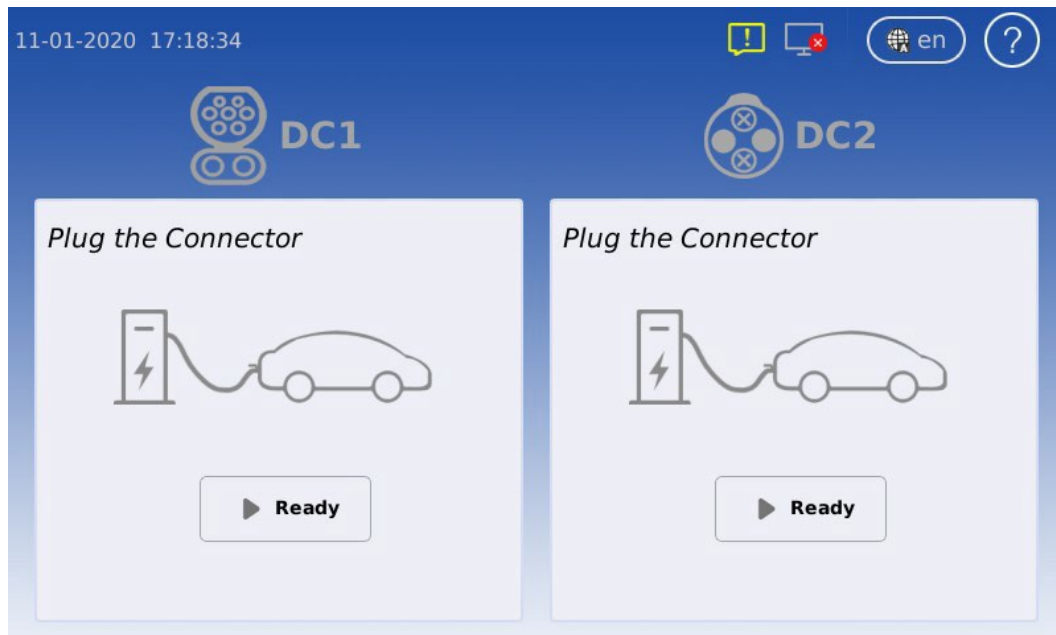

Figure 9: Charging screen



Before attempting to install or start up the charger must ensure that the safety instructions in this manual have been carefully read and observed by trained personnel. Keep this manual with the charger for future reference.

### 5.3 Indicator Lights

Indicator Light Location	Color	Meaning
DC-1	Yellow	DC-1 is currently in use
Power	Green	Power is active
Alarm	Red	Critical error is present
DC-2	Yellow	DC-2 is currently in use



## 6 User Manual

The EVSE operation depends on its output connections: CCS, CHAdeMO. During the charging process, the Human Machine Interface (HMI), will give instructions and will signal different stages. These sequences are shown in this chapter.

## 6.1 Output connector

The EVSE is prepared to charge electric vehicles according to the mentioned charging systems

### 6.1.1 CCS Connector

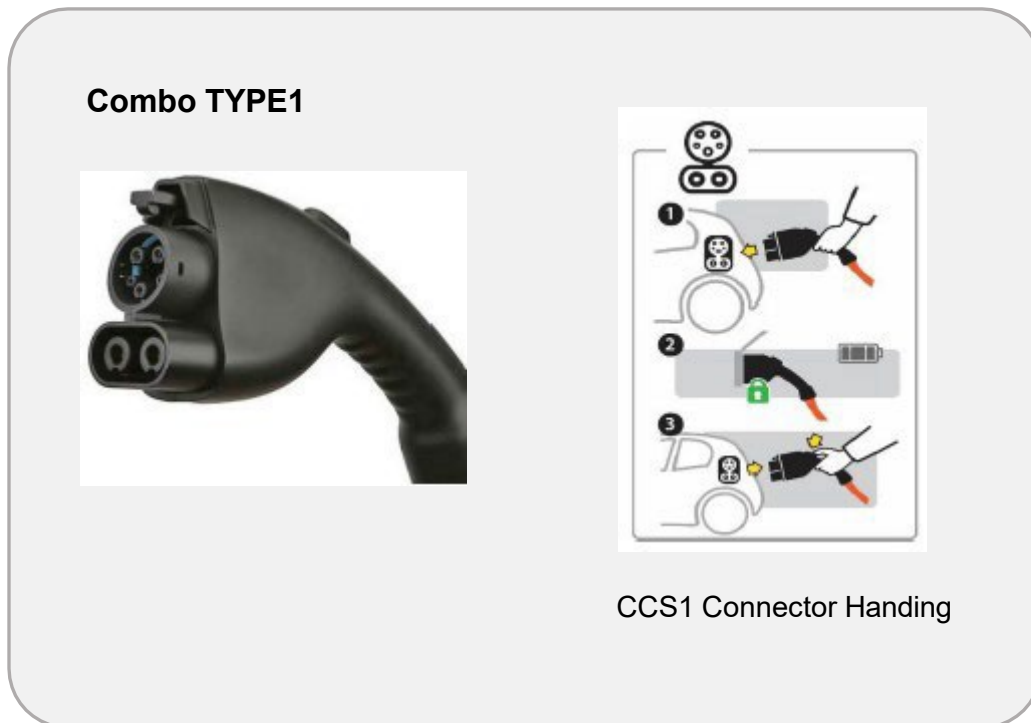

Figure 10: CCS1 Connector

### 6.1.2 CHAdeMO Connector

CHAdeMO connector has a lock button.

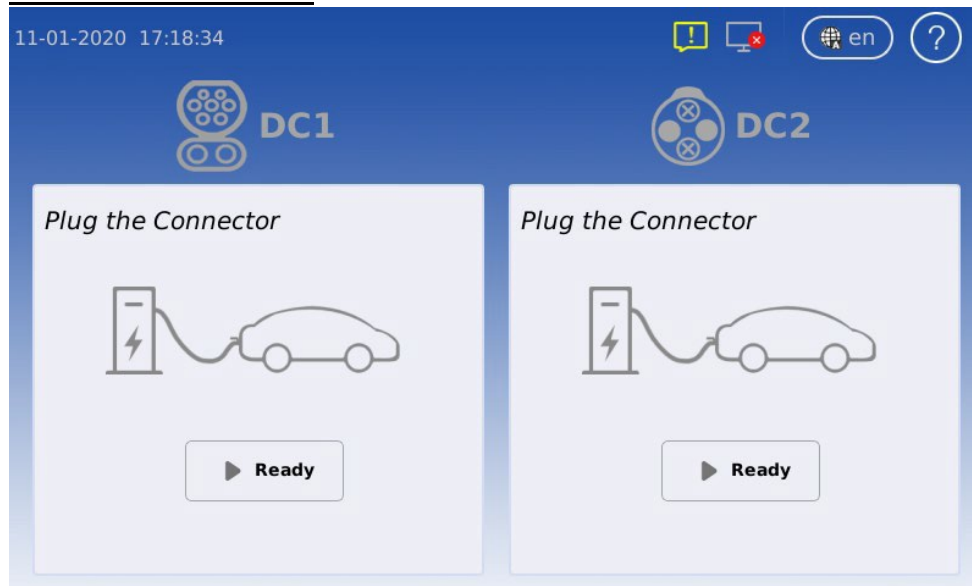

Figure 11: CHAdeMO

### 6.2 Operation instructions

When a user starts an operation on the EVSE, the HMI display will show one of the following screens.

#### CCS1+CHAdeMO Units:



- 1、 Plug the charging gun into the vehicle receptacle.
- 2、 Press “Ready on the screen.
- 3、 Waiting for the charging session to begin.
- 4、 After the vehicle is fully charged, stop charging first, then unplug the charging gun.



## Appendix 1 Engineering and Technical Parameters

- ※ The DC Charger has front and back doors. A minimum of 40in (1000mm) clearance should be provided on both sides to provide space for maintenance.
- ※ Hot ventilation air exits to the back of the machine. A minimum 40in (1000mm) clearance should be provided to prevent hot air from recirculating back to the air intake.



Note: When the system is running, the temperature of the back side door will be hot so avoid contact.

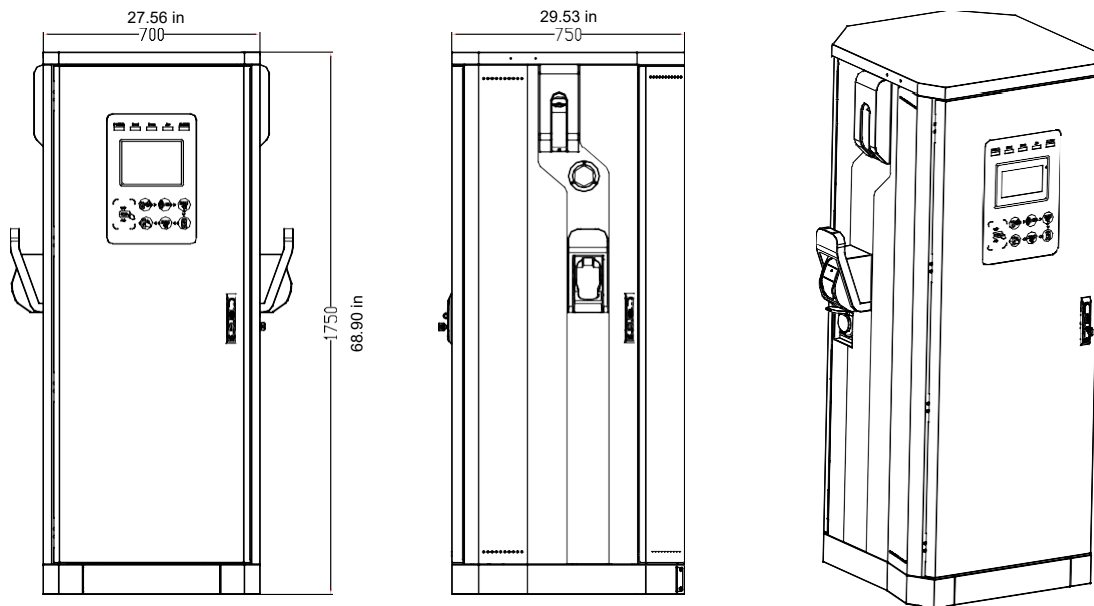

Figure 12: EVSE 3 Views

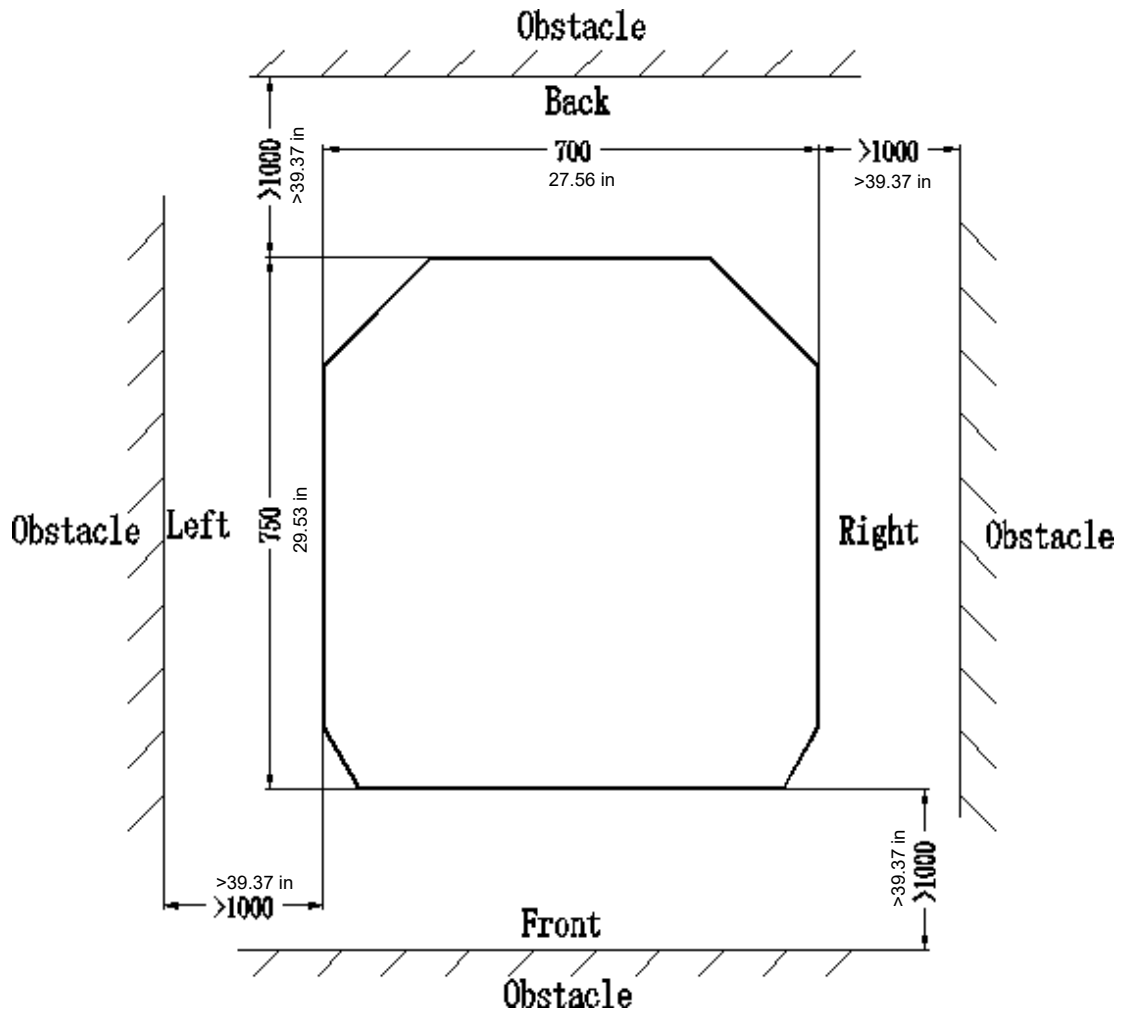
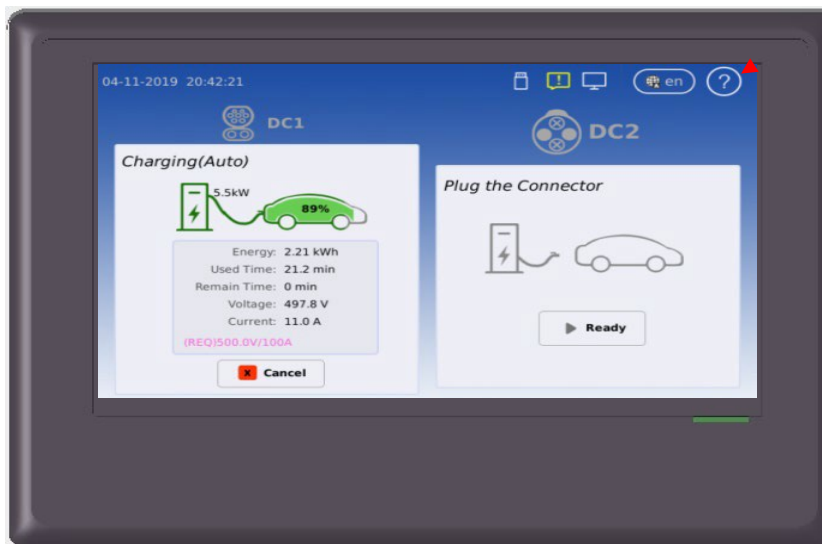

Figure 13: EVSE Space Requirement





## Appendix 2: Alarm information

- 1) Click “?” In the upper right corner of the screen and log in as Engineer or Administrator to view the error code/alarm information. Default password for Engineer is 151719. Administrator password is only to be used by qualified technicians.
- 2) If an alarm is displayed it should be addressed immediately. If it cannot be resolved, contact the manufacturer for assistance.

**Click here to view alarm information.**



### Appendix 3: Error codes and possible solutions

26-03-21 15:03 (Engineer)    en 

Active Alarm   Detailed Info   Param Set   Manual Ctrl   Charge Rec

Index	Level	Alarm Name	Source	Begin Time	Status
1	MA	Server Comm Fail	Charger System	2021/03/10 15:10:39	Started
2	CA	Communication Failed	Heat Exchange	2021/03/26 15:00:17	Started

◀ 1/1 ▶

Table: Charger_Alarms					
NO.	Alarm_ID	Alarm_Name	Alarm_Level	Description	Remark
1	1	System Not Available	CA	System is out of service and charge is not allowed. This usually comes after other critical alarm(e,g EPO pressed)	
2	2	System Disabled	MA	System is out of service and charge is not allowed. This happens after system is set to 'In-operative' by service guy or backend.	
3	3	All CCU Comm Fail(Not used right now)	CA	Note used any longer	
4	4	Server Comm Fail	MA	If the network is not accessible or the connection between server and charger is broken	
5	5	All kWh Meter Not Installed	MA	All kWh meters are set to 'Not installed'. This means the system is not available	
6	6	CCU Comm Fail	CA	The communication between IMMU2 and IMSU-D has failed. This means the system is not available	
7	7	EPO is pressed	CA	This means system not available	
8	8	Door is opened	CA	This means system not available	
9	9	SPD alarm	CA	This means system not available	
10	10	Mains Fail Alarm	CA	This means system not available	
11	11	Gun is disabled	MA	The specified gun is out of service and not allowed to charge. This happens after the gun is set to 'In-operative' by service technician or backend.	Gun A/B/C shall be specified
12	12	System over temp	MA	The temperature measurement from sensor	Note that this alarm does not stop/prohibit charge function

				is over the upper limit point(default is 75 'C)	
13	13	All Rectifier Failure	CA	This means system not available	
14	14	All Rectifier Comm Fail	CA	This means system not available	
15	15	Rectifiers Failure	CA	This means the specified gun will not be available	Rectifier group 1/2 shall be specified
16	16	Rectifiers Comm Fail	CA	This means the specified gun will not be available	Rectifier group 1/2 be specified
17	17	Insulation Comm Fail	CA	This means the specified gun will not be available	
18	18	Output Shorted	CA	This is from Rectifiers after detected the internal circuit shorted	
19	19	Insulation Alarm	CA	This is from IMSU-D after detected the insulation abnormal	
20	20	PLC ComFail Alarm	CA	This is from IMSU-D when the PLC communication is lost	
21	21	Ground Fault	CA	This is from IMSU-D after detected ground fault	
22	22	AC Fail Alarm(for AC only)	CA	This is from IMSU-D after detected AC gun input fails(DI)	
23	301	CR CommFail	CA	The communication between IMMU2 and Card Reader is failed. This usually means the authentication with RFID card loses efficacy and user has to take other method instead(e,g OTP)	
24	401	kWhMeterCommFail	CA	The communication between IMMU2 and specified kWh meter is failed. This means the specified gun will be out of service and forbid to charge	
25	402	Sampled Invalid Current	CA	The measurement from the specified kWh meter is invalid. This usually happens with a reversed	

				wiring for the current shunt.	
<i>1. CA - Critical alarm MA - Major alarm OA - Observative Alarm</i>					

Stop Reason Classification	Code	Description	Remark
Normal Stop	1	Normal Stop	Condition satisfied
	2	EV request Stop	EV Request Stop
Charger Error	201	Parameter configuration failed	
	202	Charging Enable timeout	
	203	Abnormal volt of outside bus	
	204	Unable lock charging gun	
	205	Insulation inspection anomaly	
	206	Insulation inspection timeout	
	207	EV Relay pull-In timeout	
	208	Require Curr Timeout	
	209	Remain time over stop	
	210	Ring fail alarm (reserved)	
	211	Communication with EV failed	
	212	Plugged gun timeout	
	213	Pre Charging fault	
	214	DoorOpen	
215	EPO		
216	SPD		

	217	AllRectFail	
	218	MainsFailAlm	
	219	AIRectCommFail	
	220	E_LockFail	
	221	GunOverTemp	
	222	OutputShortCircuit	
	223	PWM Failure	
	224	Ground Fault Detected	
	250	CR Comm Fail	
	251	kWhMeterComm Fail	
	252	CCU Comm Fail	
	EV Error	301	Battery overvoltage
302		Battery undervoltage	
303		Battery current deviation error	
304		High battery temperature	
305		Battery voltage deviation error	
306		Charger Connector Lock Fault	
307		Vehicle shift position	
308		Error Status Noticed by EV	
309		PLC Low Level Comm Fail	
310		PLC High Level Comm Fail	
311		PLC Authentication Timeout	
312		PLC ParamDiscovery Timeout	
Canceled	401	Local Stop	
	402	Server Stop	
	403	Network fault	



	404	Reboot	
	405	DeAuthorized	
	406	One-Click Stop	
	407	Hard Reset	
	408	Soft Reset	
Other	501	Other	